

Article number: 20131B18B182SW
Description: E+G Two-way connector
GN131-B18-B18-2-SW

Measures

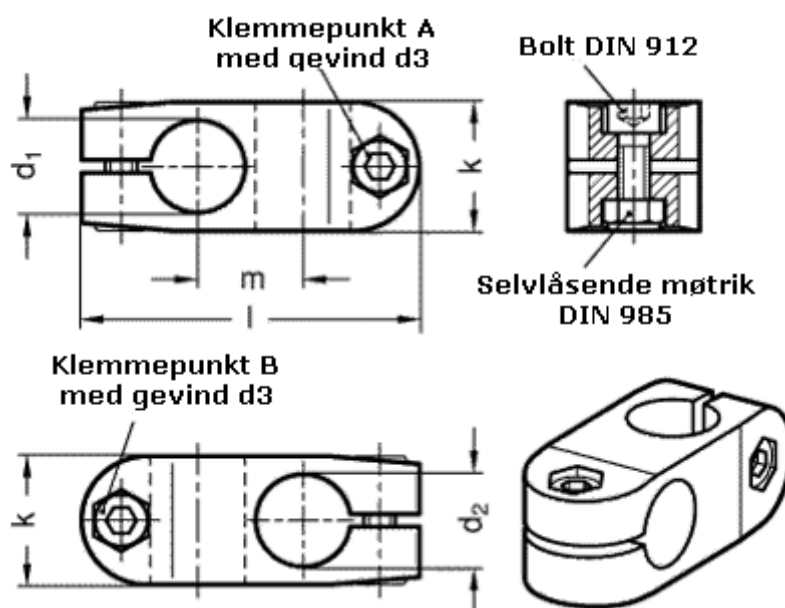

Adjustable clamp lever = GN 911-M 6-22 have to be ordered separately

d1	= 18
d2	= 18
d3	= M 6
k	= 25
l1	= 64
m	= 20